



1 Fast Finisher Worksheet 1

Name: _____

Class: _____



Find, colour and trace.  Say.

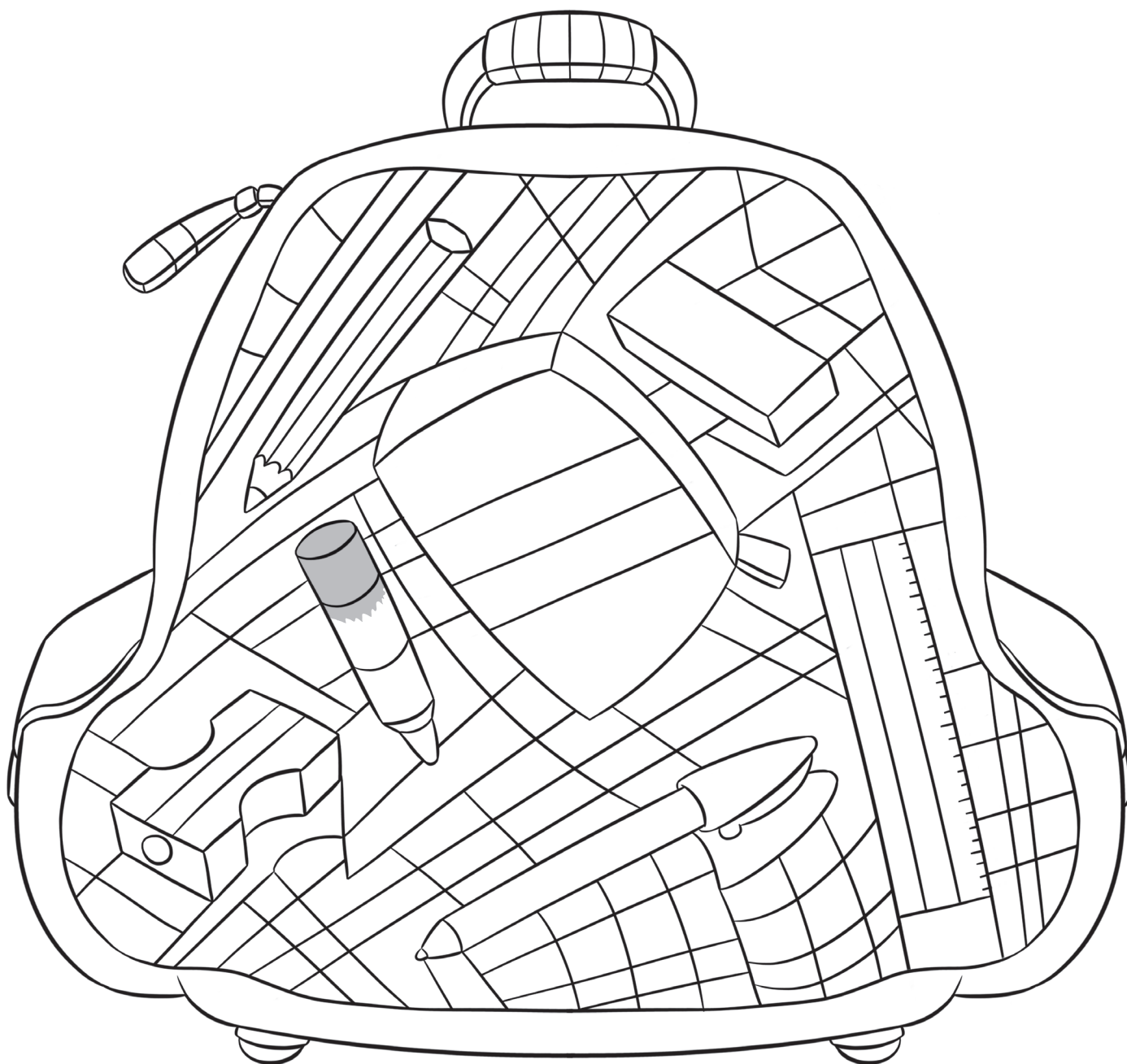

- 1 crayon
- 2 pencil case
- 3 sharpener
- 4 rubber

- 5 ruler
- 6 pen
- 7 pencil

- Find and colour the seven classroom objects in the bag.
- Trace the words. Say *A (green) crayon.*





1 Reading and Writing Worksheet 1

Name: _____

Class: _____

 Trace, read and number.

- 1** *pencil case* **2** *ruler* **3** *pen* **4** *pencil*
5 *rubber* **6** *sharpener* **7** *crayon* **8** *bag*

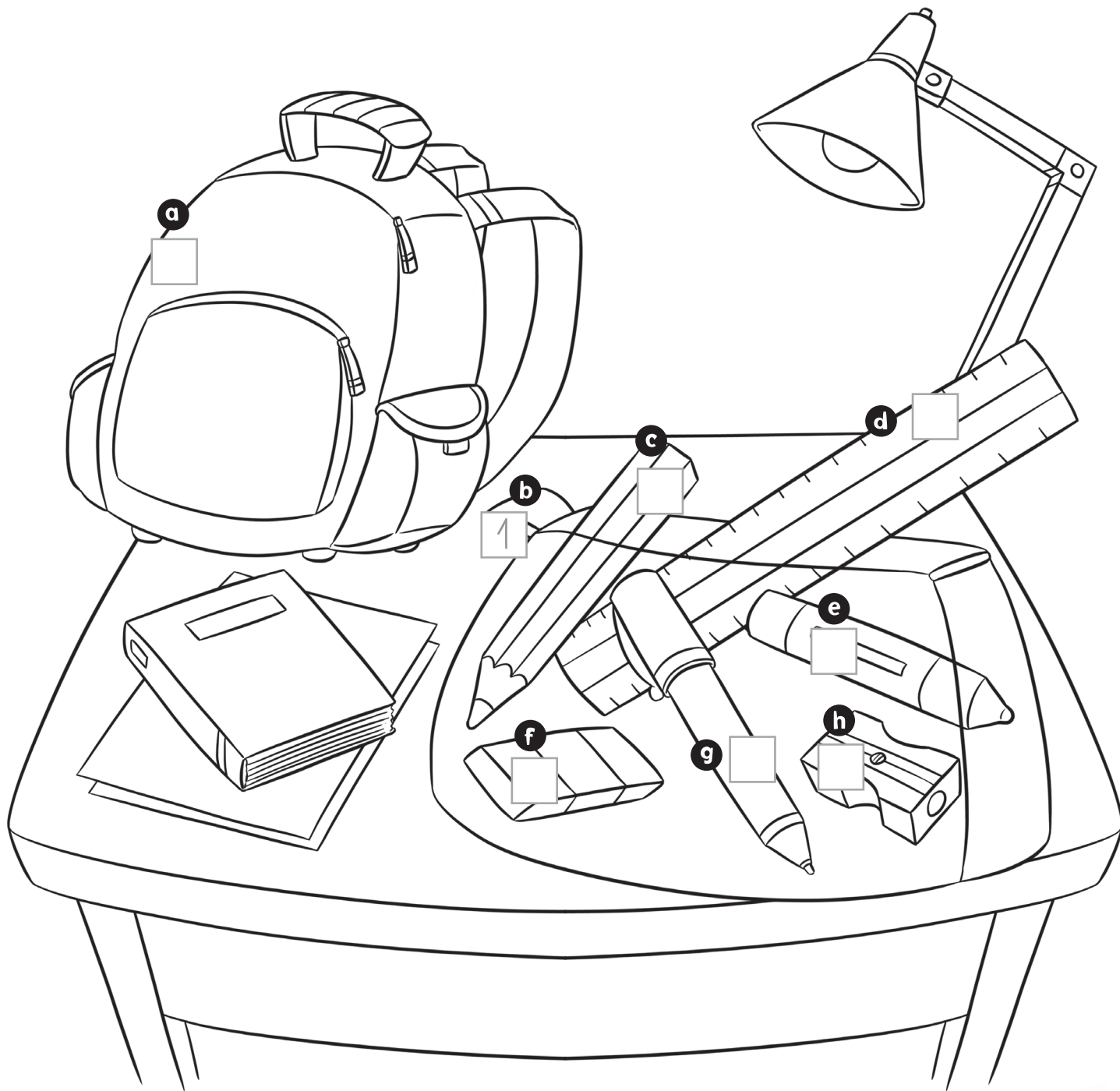

- Trace the words.
- Read the words and number the classroom objects.





Fast Finisher Worksheet 1

Name: _____

Class: _____



Trace, colour and match.  Say.

eyes

ears

head

mouth

legs

hands

nose

arms

- Trace the body parts and colour the pirate. Then match to the words.
- Point to and name the parts of the body. Say *I've got (eyes)*.





2 Reading and Writing Worksheet 1

Name: _____

Class: _____

Trace and match.

1 *mouth*

2 *arms*

3 *eyes*

4 *hands*

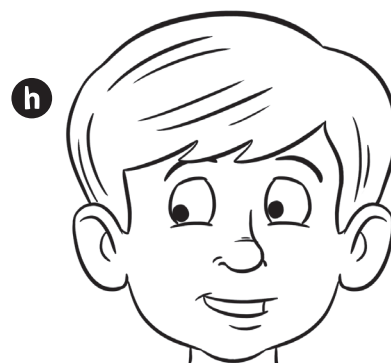
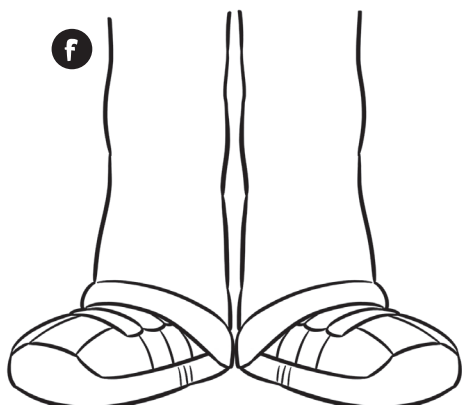

5 *nose*

6 *head*

7 *ears*

8 *legs*

- Trace the words.
- Match the words to the correct picture.

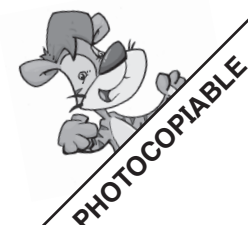



3 Reading and Writing Worksheet 2

Name: _____

Class: _____

 Circle and trace.



grandfather

uncle

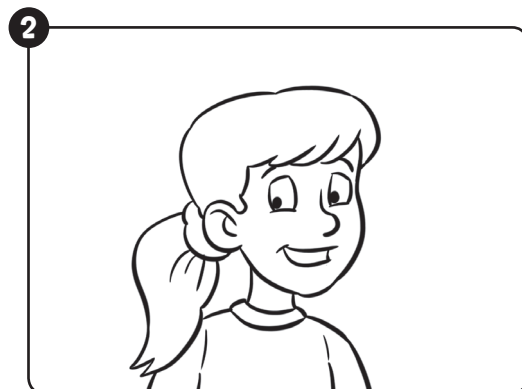

baby
cousin



aunt
grandmother

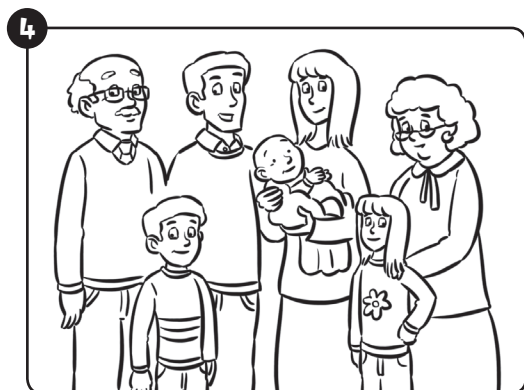

big family
small family

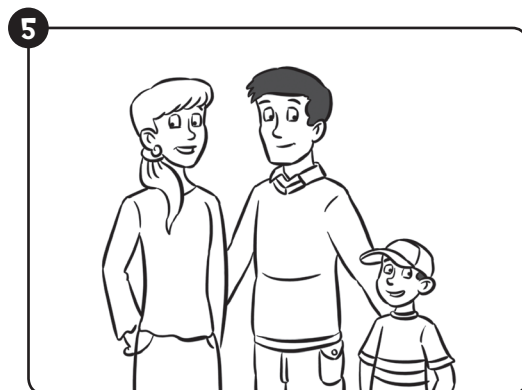

big family
small family

• Circle and trace the correct words for each picture.





Name: _____

Class: _____

Find and circle. Look and write.

cheese carrotshameggspreamilkpotatoessausages

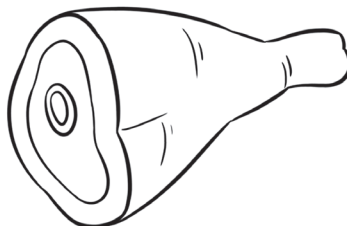
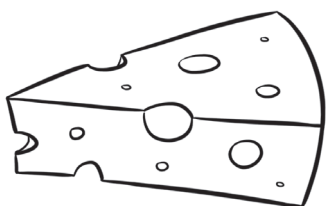

1 cheese

2 _____

3 _____

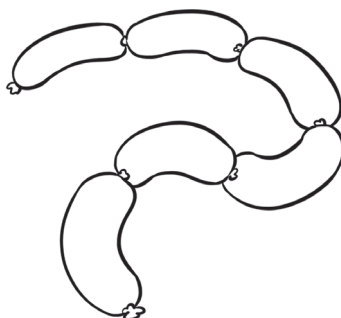
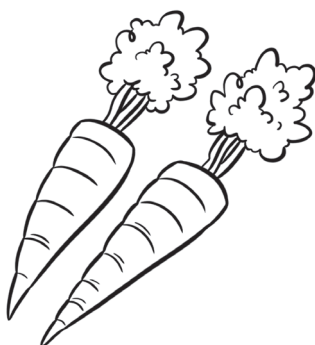

4 _____

5 _____

6 _____



7 _____

8 _____

- Find and circle the food words.
- Write the words under the correct picture.



Name: _____

Class: _____

Look and match. Read and write.

~~fruit~~ vegetables meat fish

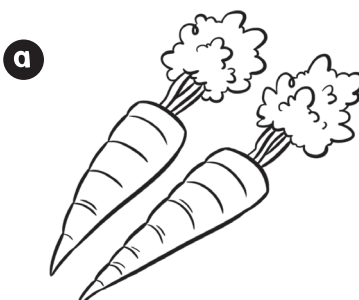
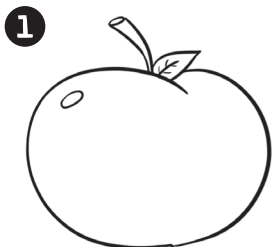

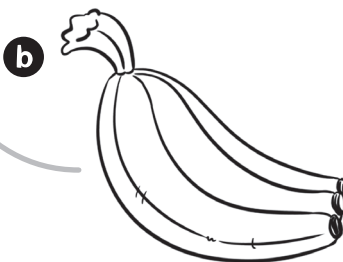
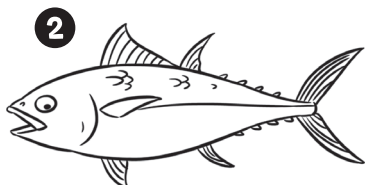

fruit

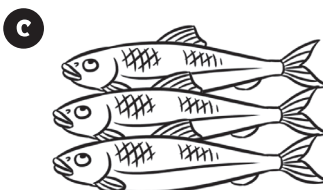
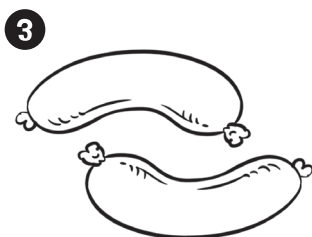

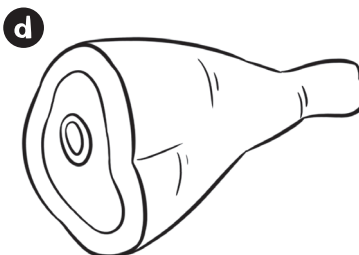
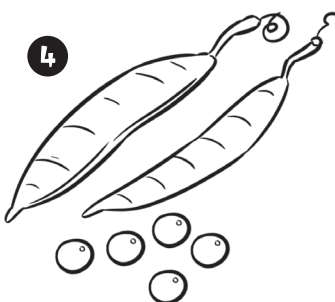

- Match the food items in the same food category.
- Read and write the names of the food categories next to the correct picture.